

1 2 3 4 5 6

A

B

C

D

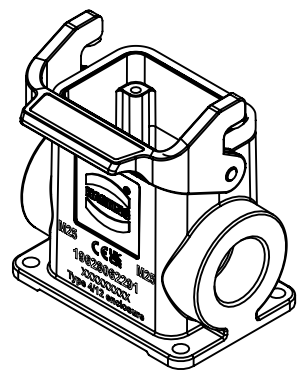
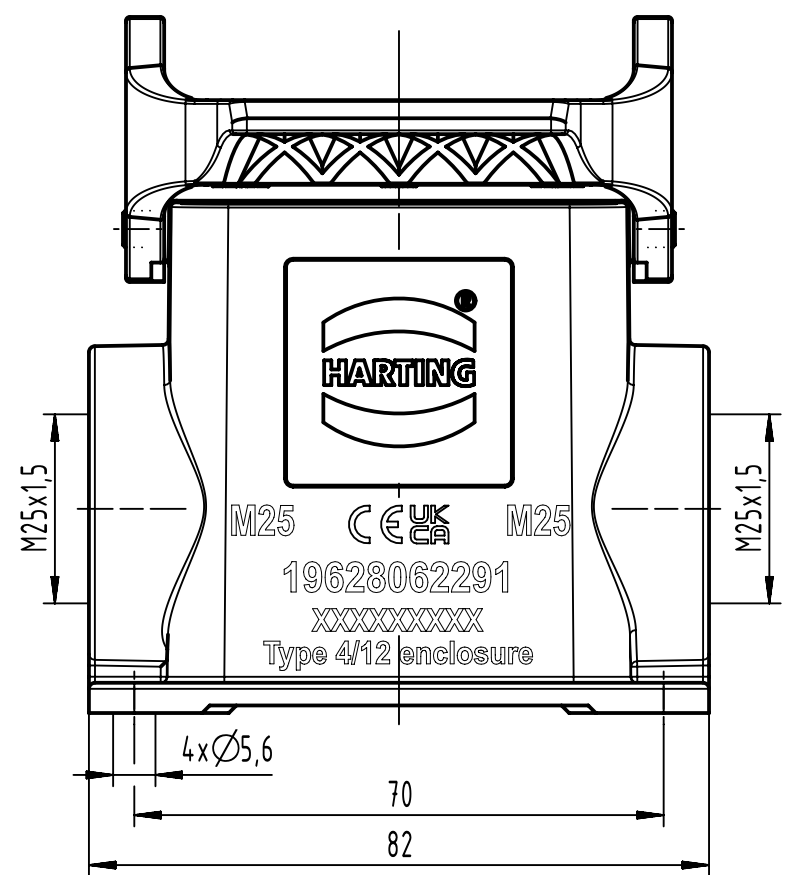
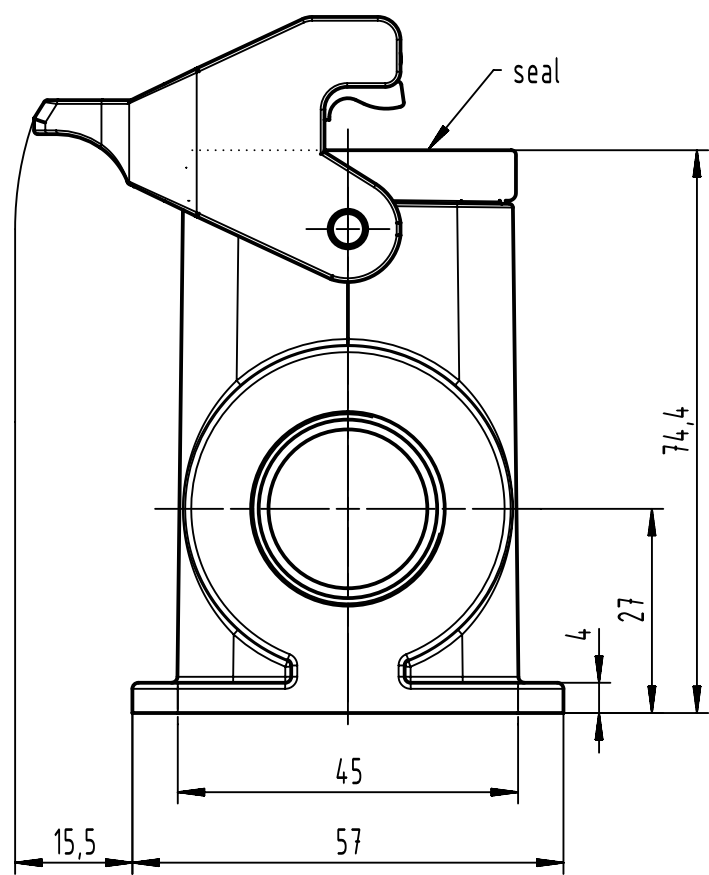

	All Dimensions in mm Original Size DIN A4		Scale 1:1	Free size tol.		Ref.
						Sub.
	All rights reserved		Created by CHENSK	Inspected by LUOK	Standardisation ROEBEN	Date 2023-08-14
	Department EL PD					State Final Release
HARTING			Title Han EMC/B 6B HSM2 HC SL M25			Doc-Key / ECM-Nr. 101010833/UGD/001/B 500000251553
D-32339 Espelkamp			Type TB	Number 19 62 806 2291		
						Rev. B
						Page 1/1